

# BUSTER + PUNCH

## BUSTER BULB / TEARDROP

TECH SPEC



BUSTER BULB / CRYSTAL



BUSTER BULB / GOLD



BUSTER BULB / SMOKED

### BUSTER BULB

The World's first designer LED bulb. This bulb consumes just 1/20th of the energy of traditional bulbs with a life span of 30,000 hours. Available in CRYSTAL, GOLD or SMOKED finish. The resin light pipe at the centre of the bulb is where all the magic happens, allowing the bulb to create a subtle ambient light whilst at the same time throw focused spot light onto tables & surfaces below. The bulb fits in any E27 screw light fitting, but looks especially great when teamed up with our HEAVY METAL or HOOKED lighting ranges.







[busterandpunch.com](http://busterandpunch.com)  
[info@busterandpunch.com](mailto:info@busterandpunch.com)

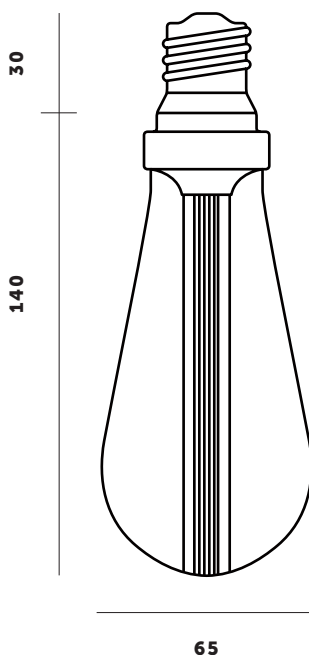

**BUSTER BULB / TEARDROP / DIMMABLE**

TECH SPEC



FINISH	SKU	FINISH	SKU
 Crystal / Dimmable / Polycarbonate	<b>BB-TD-E27-D-CR-C</b>	 Crystal / Dimmable / Glass	<b>CBB-121026</b>
 Gold / Dimmable / Polycarbonate	<b>BB-TD-E27-D-GO-C</b>	 Gold / Dimmable / Glass	<b>CBB-131028</b>
 Smoked / Dimmable / Polycarbonate	<b>BB-TD-E27-D-SM-C</b>	 Smoked / Dimmable / Glass	<b>CBB-091027</b>

SPECIFICATIONS	
<p><b>Power:</b> 5W  <b>Type:</b> Dimmable LED  <b>Screw fitting:</b> E27  <b>Supply:</b> 240 VAC  <b>Expected Life:</b> 30 000 hrs  <b>Lumen:</b> Crystal max 250, Gold max 200, Smoked max 130.  <b>Light appearance:</b> Crystal 2700k, Gold 2500k, Smoked 2600k.  <b>CRI:</b> 80</p>	<p><b>Power factor:</b> 0.88  <b>Recommended dimmer module:</b> Buster + Punch LED module. (Sold with our dimmer switches)  <b>Please note:</b> Not suitable for DALI dimming systems.  <b>CE certified.*</b>  <b>For indoor use only.</b></p>

**CARE INSTRUCTIONS**

Wipe with damp cloth with no loose hairs, avoid using any chemicals. Please note all finishes are prone to aging.

\* Official data doc can be supplied upon request.

# SPECTRAL IRRADIANCE AT 3M

5W DIMMABLE

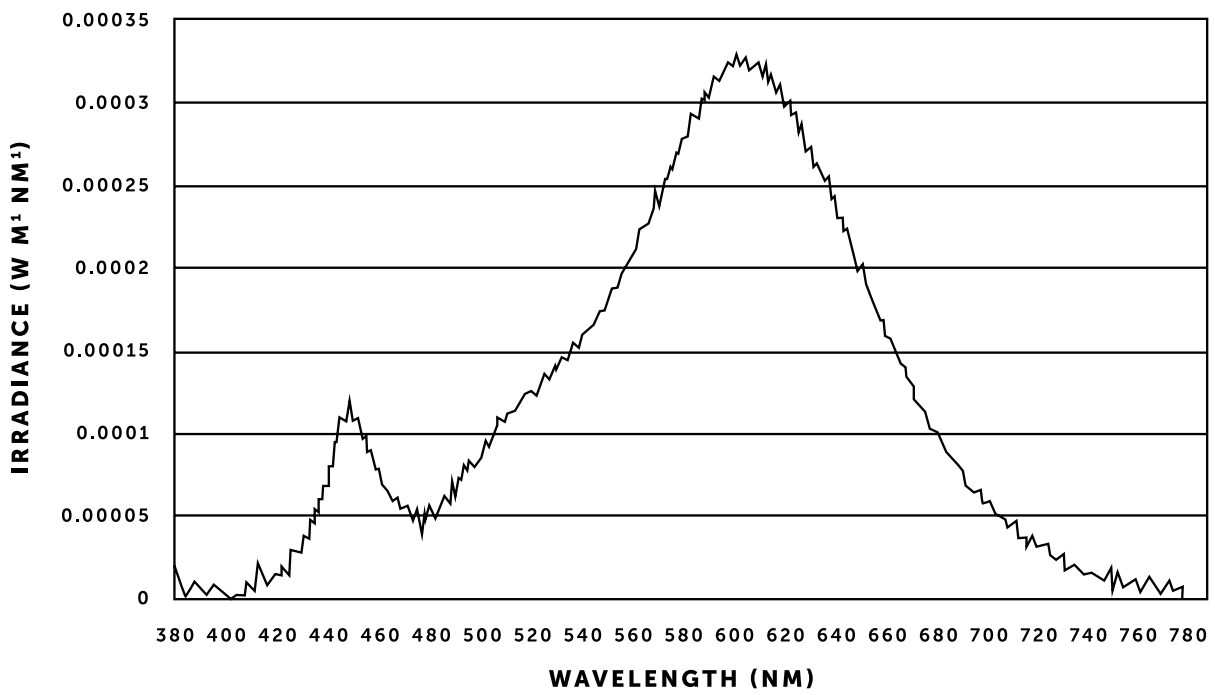

busterandpunch.com  
info@busterandpunch.com

# POLAR CANDELA DISTRIBUTION

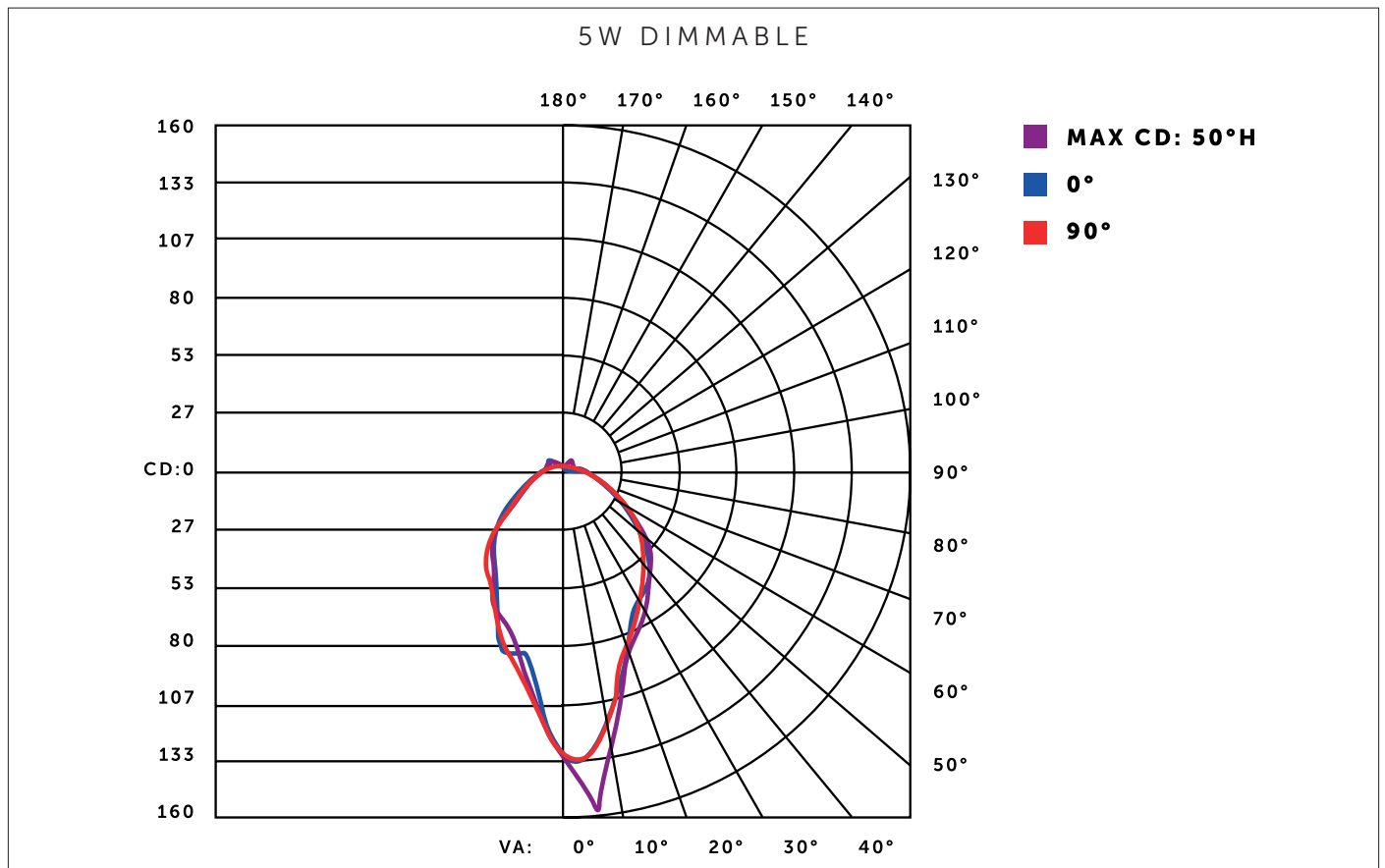

busterandpunch.com  
info@busterandpunch.com

# CRI 1931

5W DIMMABLE

CIE 1931 Chromaticity Cx: 0.4629  
CIE 1931 Chromaticity Cy: 0.4145

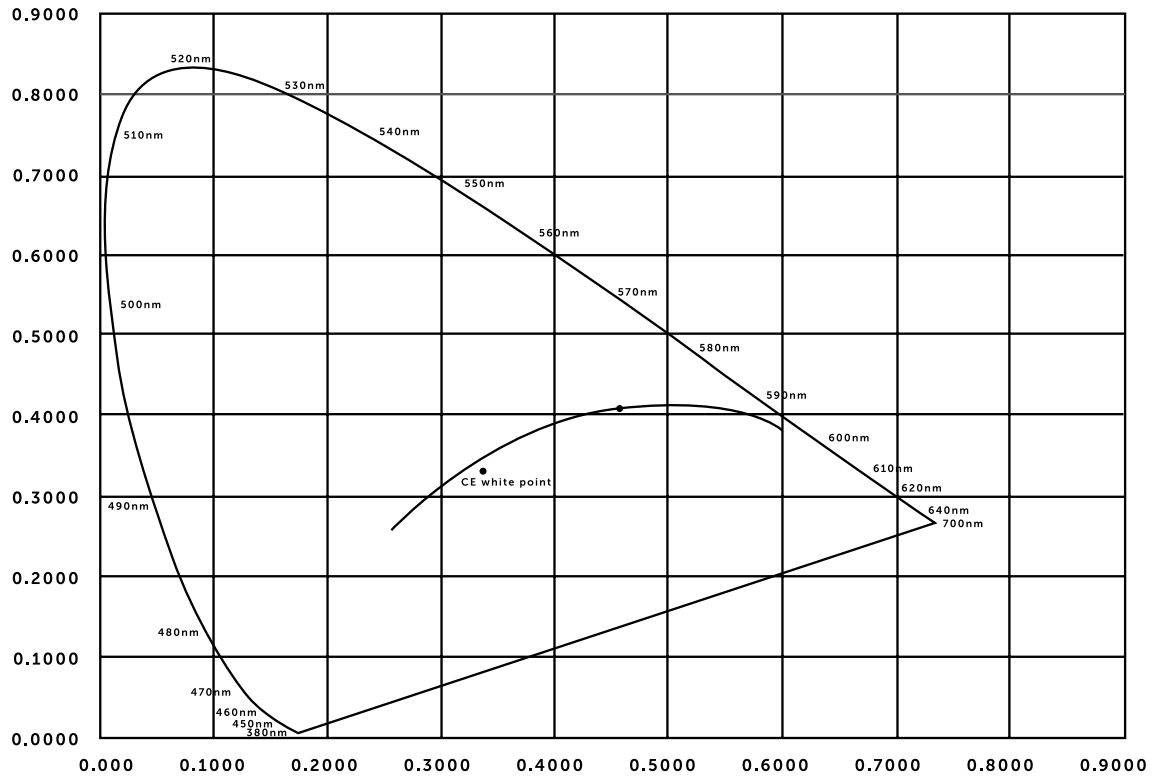

busterandpunch.com  
info@busterandpunch.com